

Spec Sheet STP310500120S

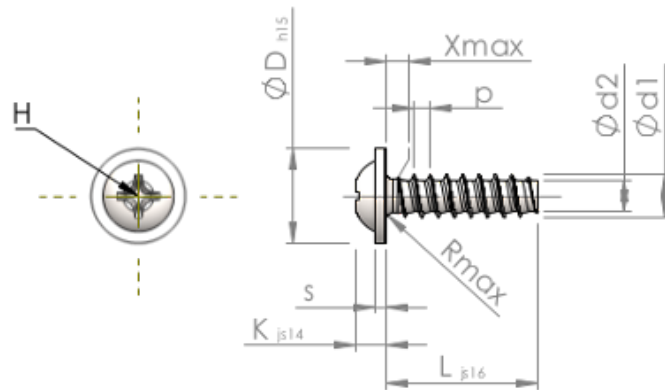

Item Number		STP310500120S
Standard		KN6031
Material		steel, hardened
Surface		zinc-plated 5-7 μm , baked, blue / transparent passivated
Thread Outside- Ø	d1	5.00 $^{+0.15}$ mm
Thread Core- Ø	d2	3.53 mm
Thread Pitch	p	1.80 mm
Length	L	12.00 ± 0.55 mm
Head- Ø	D	11.00 $_{-0.70}$ mm
Head Height	K	3.200 ± 0.150 mm
Flange Thickness	S	1.20 mm
Thread Run-Out	X	2.50 mm
Radius	R	0.70 mm
Size Cross Recess		H2
Penetration Depth	t	1.98 - 2.61 mm
Thread		STS-plus
Weight		2.415 kg / 1000 pieces
Customs Tariff No		73 181 499