

Spec Sheet STP310450500E

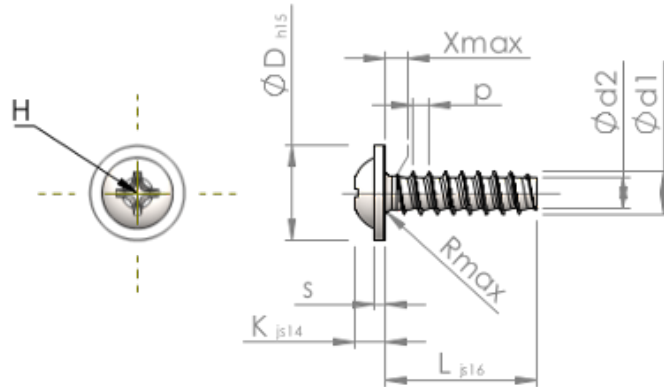

Item Number		STP310450500E
Standard		KN6031
Material		stainless-steel A2
Surface		bright, pickled and passivated
Thread Outside-Ø	<b>d1</b>	4.50 <sup>+0.10</sup> mm
Thread Core-Ø	<b>d2</b>	3.17 mm
Thread Pitch	<b>p</b>	1.63 mm
Length	<b>L</b>	50.00 ±0.80 mm
Head-Ø	<b>D</b>	10.00 <sub>-0.58</sub> mm
Head Height	<b>K</b>	2.500 ±0.125 mm
Flange Thickness	<b>S</b>	1.00 mm
Thread Run-Out	<b>X</b>	2.30 mm
Radius	<b>R</b>	0.60 mm
Size Cross Recess		H2
Penetration Depth	<b>t</b>	1.33 - 1.96 mm
Thread		STS-plus
Weight		4.579 kg / 1000 pieces
Customs Tariff No		73 181 410