

Spec Sheet STP310450140E

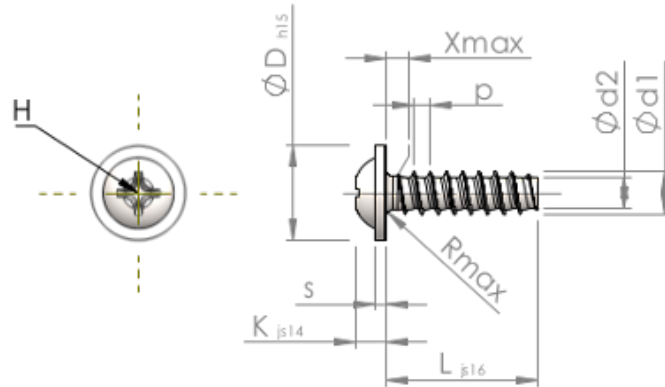

Item Number		STP310450140E
Standard		KN6031
Material		stainless-steel A2
Surface		bright, pickled and passivated
Thread Outside-Ø	d1	4.50 ^{+0.10} mm
Thread Core-Ø	d2	3.17 mm
Thread Pitch	p	1.63 mm
Length	L	14.00 ±0.55 mm
Head-Ø	D	10.00 _{-0.58} mm
Head Height	K	2.500 ±0.125 mm
Flange Thickness	S	1.00 mm
Thread Run-Out	X	2.30 mm
Radius	R	0.60 mm
Size Cross Recess		H2
Penetration Depth	t	1.33 - 1.96 mm
Thread		STS-plus
Weight		1.811 kg / 1000 pieces
Customs Tariff No		73 181 410