

Spec Sheet STP310450100S

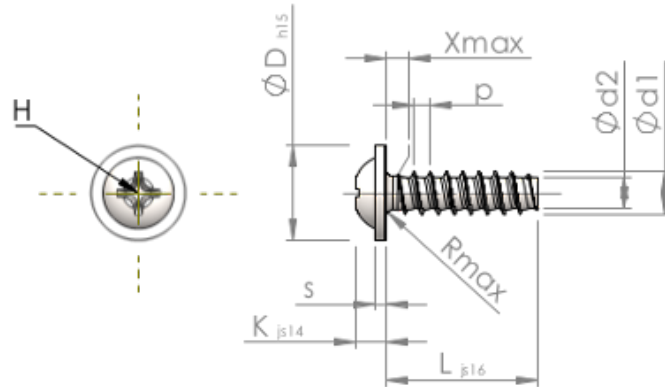

Item Number		STP310450100S
Standard		KN6031
Material		steel, hardened
Surface		zinc-plated 5-7 μ m, baked, blue / transparent passivated
Thread Outside- \varnothing	d1	4.50 $^{+0.10}$ mm
Thread Core- \varnothing	d2	3.17 mm
Thread Pitch	p	1.63 mm
Length	L	10.00 ± 0.45 mm
Head- \varnothing	D	10.00 $_{-0.58}$ mm
Head Height	K	2.500 ± 0.125 mm
Flange Thickness	S	1.00 mm
Thread Run-Out	X	2.30 mm
Radius	R	0.60 mm
Size Cross Recess		H2
Penetration Depth	t	1.33 - 1.96 mm
Thread		STS-plus
Weight		1.503 kg / 1000 pieces
Customs Tariff No		73 181 499