

Technische gegevens
STP310400400E

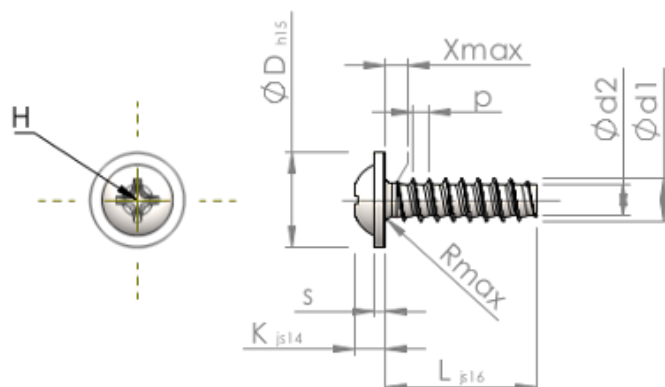

SCREWERK



Produktnummer		STP310400400E
Norm		KN6031
Materiaal		roestvrij staal A2
Oppervlak		blank, geetst en gepassiveerd
Schroefdraad buiten-Ø	d1	4.00 ^{+0.10} mm
Schroefdraad kern-Ø	d2	2.81 mm
Spoed	p	1.46 mm
Lengte	L	40.00 ±0.80 mm
Kop-Ø	D	9.00 _{-0.58} mm
Kop hoogte	K	2.500 ±0.125 mm
Flensdikte	S	1.00 mm
Draaduitloop	X	2.00 mm
Radius	R	0.60 mm
Kruis Maat		H2
Indringdiepte	t	1.33 - 1.96 mm
Draad		STS-plus
Gewicht		3.063 kg / 1000 stuk
Douane tarief nummer		73 181 410