

Technische gegevens
STP310400170B

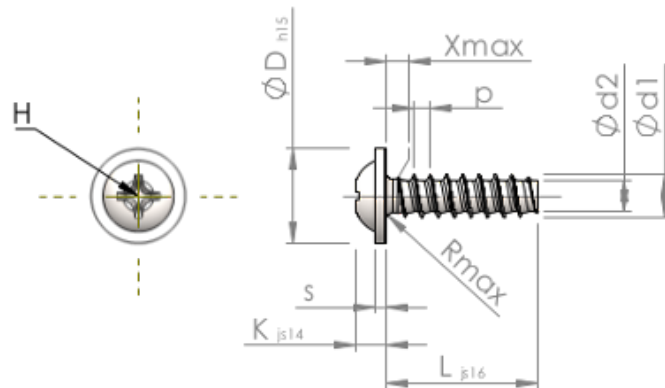

| | | |
|-----------------------|-----------|---|
| Produktnummer | | STP310400170B |
| Norm | | KN6031 |
| Materiaal | | veredeld staal |
| Oppervlak | | ZnNi zwart-gepassiveerd, getempert, verzegeld |
| Schroefdraad buiten-Ø | d1 | 4.00 ^{+0.10} mm |
| Schroefdraad kern-Ø | d2 | 2.81 mm |
| Spoed | p | 1.46 mm |
| Lengte | L | 17.00 ±0.55 mm |
| Kop-Ø | D | 9.00 _{-0.58} mm |
| Kop hoogte | K | 2.500 ±0.125 mm |
| Flensdikte | S | 1.00 mm |
| Draaduitloop | X | 2.00 mm |
| Radius | R | 0.60 mm |
| Kruis Maat | | H2 |
| Indringdiepte | t | 1.33 - 1.96 mm |
| Draad | | STS-plus |
| Gewicht | | 1.694 kg / 1000 stuk |
| Douane tarief nummer | | 73 181 499 |