

Spec Sheet STP310400080B

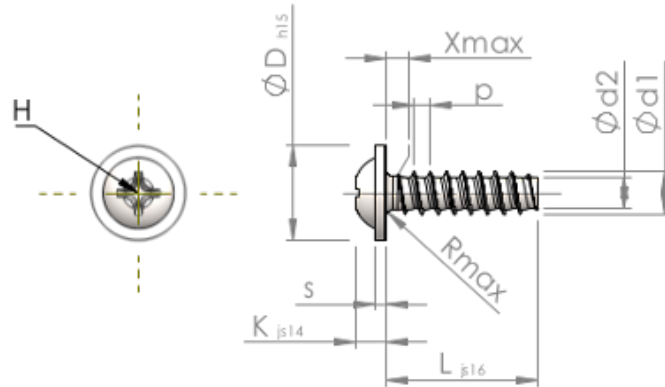

Item Number		STP310400080B
Standard		KN6031
Material		steel, hardened
Surface		Zinc-Nickel-plated min. 5µm, passivated black/ Cr-VI-free, baked, sealed
Thread Outside-Ø	d1	4.00 ^{+0.10} mm
Thread Core-Ø	d2	2.81 mm
Thread Pitch	p	1.46 mm
Length	L	8.00 ±0.45 mm
Head-Ø	D	9.00 _{-0.58} mm
Head Height	K	2.500 ±0.125 mm
Flange Thickness	S	1.00 mm
Thread Run-Out	X	2.00 mm
Radius	R	0.60 mm
Size Cross Recess		H2
Penetration Depth	t	1.33 - 1.96 mm
Thread		STS-plus
Weight		1.158 kg / 1000 pieces
Customs Tariff No		73 181 499