

Technische gegevens
STP310350400E

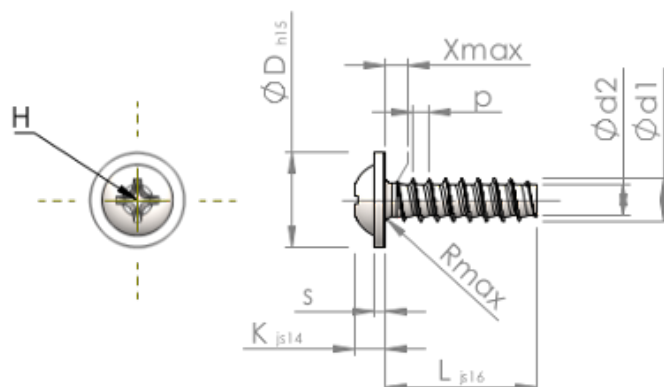

SCREWERK



Produktnummer		STP310350400E
Norm		KN6031
Materiaal		roestvrij staal A2
Oppervlak		blank, geetst en gepassiveerd
Schroefdraad buiten-Ø	d1	3.50 ^{+0.10} mm
Schroefdraad kern-Ø	d2	2.45 mm
Spoed	p	1.29 mm
Lengte	L	40.00 ±0.80 mm
Kop-Ø	D	7.50 _{-0.58} mm
Kop hoogte	K	2.400 ±0.125 mm
Flensdikte	S	0.90 mm
Draaduitloop	X	1.80 mm
Radius	R	0.50 mm
Kruis Maat		H2
Indringdiepte	t	1.07 - 1.70 mm
Draad		STS-plus
Gewicht		2.319 kg / 1000 stuk
Douane tarief nummer		73 181 410