

Spec Sheet STP310350200S

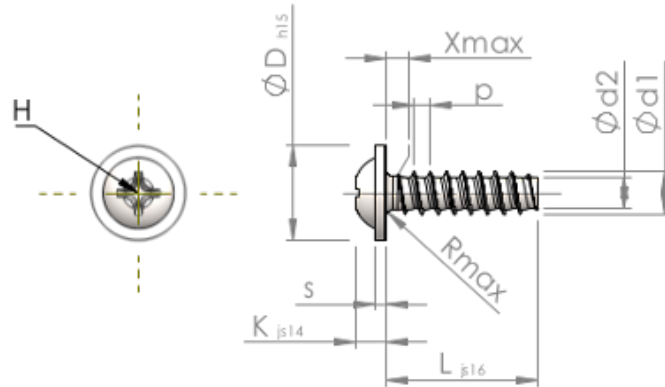

Item Number		STP310350200S
Standard		KN6031
Material		steel, hardened
Surface		zinc-plated 5-7 μ m, baked, blue / transparent passivated
Thread Outside- \varnothing	d1	3.50 $^{+0.10}$ mm
Thread Core- \varnothing	d2	2.45 mm
Thread Pitch	p	1.29 mm
Length	L	20.00 ± 0.65 mm
Head- \varnothing	D	7.50 $_{-0.58}$ mm
Head Height	K	2.400 ± 0.125 mm
Flange Thickness	S	0.90 mm
Thread Run-Out	X	1.80 mm
Radius	R	0.50 mm
Size Cross Recess		H2
Penetration Depth	t	1.07 - 1.70 mm
Thread		STS-plus
Weight		1.374 kg / 1000 pieces
Customs Tariff No		73 181 499