

**Technische gegevens**  
**STP310350170S**

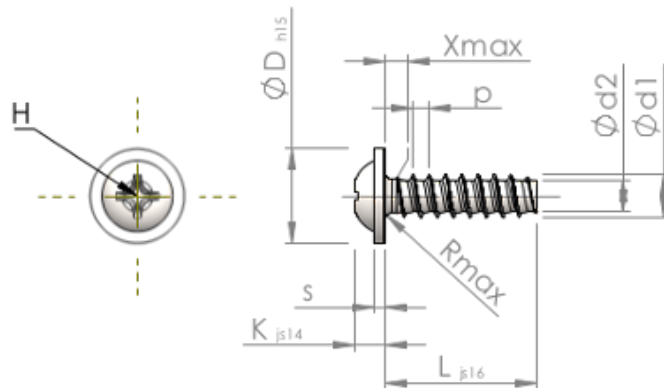

Produktnummer		STP310350170S
Norm		KN6031
Materiaal		veredeld staal
Oppervlak		verzinkt 5-7 µm, getempert, blauw / transparant gepassiveerd
Schroefdraad buiten-Ø	<b>d1</b>	3.50 <sup>+0.10</sup> mm
Schroefdraad kern-Ø	<b>d2</b>	2.45 mm
Spoed	<b>p</b>	1.29 mm
Lengte	<b>L</b>	17.00 ±0.55 mm
Kop-Ø	<b>D</b>	7.50 <sub>-0.58</sub> mm
Kop hoogte	<b>K</b>	2.400 ±0.125 mm
Flensdikte	<b>S</b>	0.90 mm
Draaduitloop	<b>X</b>	1.80 mm
Radius	<b>R</b>	0.50 mm
Kruis Maat		H2
Indringdiepte	<b>t</b>	1.07 - 1.70 mm
Draad		STS-plus
Gewicht		1.232 kg / 1000 stuk
Douane tarief nummer		73 181 499