

Spec Sheet STP310350120E

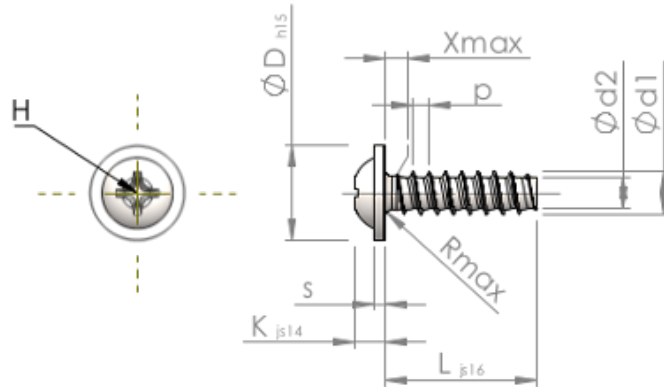

Item Number		STP310350120E
Standard		KN6031
Material		stainless-steel A2
Surface		bright, pickled and passivated
Thread Outside-Ø	<b>d1</b>	3.50 <sup>+0.10</sup> mm
Thread Core-Ø	<b>d2</b>	2.45 mm
Thread Pitch	<b>p</b>	1.29 mm
Length	<b>L</b>	12.00 ±0.55 mm
Head-Ø	<b>D</b>	7.50 <sub>-0.58</sub> mm
Head Height	<b>K</b>	2.400 ±0.125 mm
Flange Thickness	<b>S</b>	0.90 mm
Thread Run-Out	<b>X</b>	1.80 mm
Radius	<b>R</b>	0.50 mm
Size Cross Recess		H2
Penetration Depth	<b>t</b>	1.07 - 1.70 mm
Thread		STS-plus
Weight		0.996 kg / 1000 pieces
Customs Tariff No		73 181 410