

Spec Sheet STP310350100C

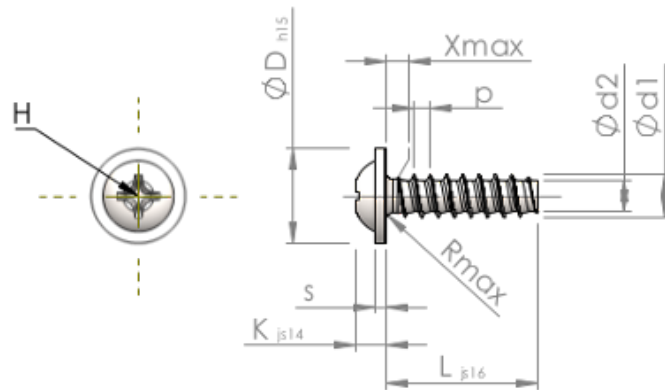

Item Number		STP310350100C
Standard		KN6031
Material		stainless steel A4
Surface		bright, pickled and passivated
Thread Outside-Ø	d1	3.50 ^{+0.10} mm
Thread Core-Ø	d2	2.45 mm
Thread Pitch	p	1.29 mm
Length	L	10.00 ±0.45 mm
Head-Ø	D	7.50 _{-0.58} mm
Head Height	K	2.400 ±0.125 mm
Flange Thickness	S	0.90 mm
Thread Run-Out	X	1.80 mm
Radius	R	0.50 mm
Size Cross Recess		H2
Penetration Depth	t	1.07 - 1.70 mm
Thread		STS-plus
Weight		0.901 kg / 1000 pieces
Customs Tariff No		73 181 410