

Spec Sheet STP310300160C

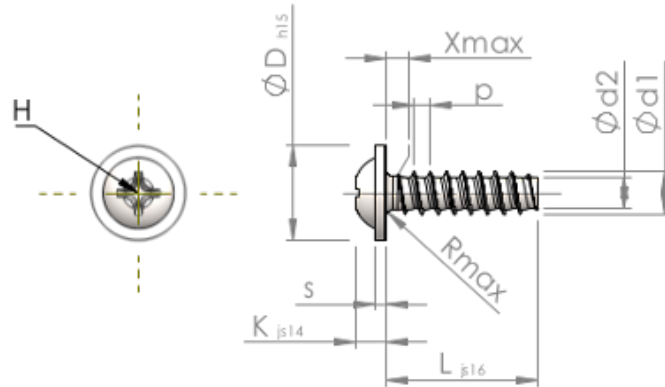

Item Number		STP310300160C
Standard		KN6031
Material		stainless steel A4
Surface		bright, pickled and passivated
Thread Outside-Ø	d1	3.00 ^{+0.10} mm
Thread Core-Ø	d2	2.09 mm
Thread Pitch	p	1.12 mm
Length	L	16.00 ±0.55 mm
Head-Ø	D	6.50 _{-0.58} mm
Head Height	K	2.100 ±0.125 mm
Flange Thickness	S	0.80 mm
Thread Run-Out	X	1.50 mm
Radius	R	0.50 mm
Size Cross Recess		H1
Penetration Depth	t	1.15 - 1.61 mm
Thread		STS-plus
Weight		0.820 kg / 1000 pieces
Customs Tariff No		73 181 410