

Technische gegevens
STP310300080S

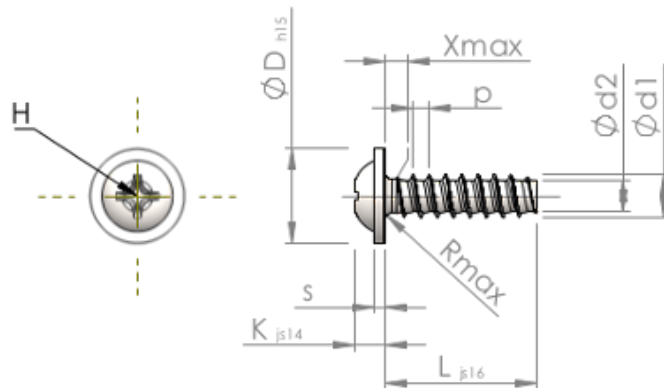

Produktnummer		STP310300080S
Norm		KN6031
Materiaal		veredeld staal
Oppervlak		verzinkt 5-7 µm, getempert, blauw / transparant gepassiveerd
Schroefdraad buiten-Ø	d1	3.00 ^{+0.10} mm
Schroefdraad kern-Ø	d2	2.09 mm
Spoed	p	1.12 mm
Lengte	L	8.00 ±0.45 mm
Kop-Ø	D	6.50 _{-0.58} mm
Kop hoogte	K	2.100 ±0.125 mm
Flensdikte	S	0.80 mm
Draaduitloop	X	1.50 mm
Radius	R	0.50 mm
Kruis Maat		H1
Indringdiepte	t	1.15 - 1.61 mm
Draad		STS-plus
Gewicht		0.548 kg / 1000 stuk
Douane tarief nummer		73 181 499