

**Technische gegevens**  
**STP310300070B**

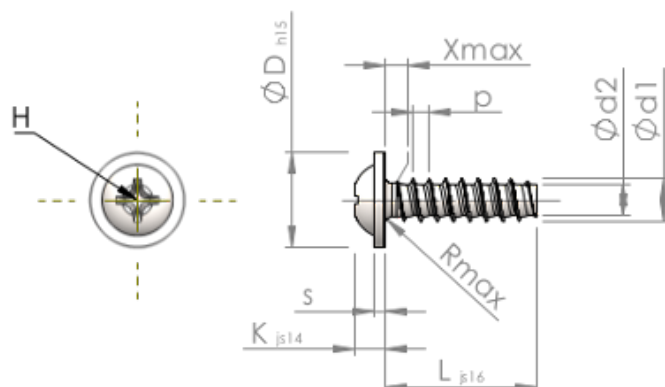

Produktnummer		STP310300070B
Norm		KN6031
Materiaal		veredeld staal
Oppervlak		ZnNi zwart-gepassiveerd, getempert, verzegeld
Schroefdraad buiten-Ø	<b>d1</b>	3.00 <sup>+0.10</sup> mm
Schroefdraad kern-Ø	<b>d2</b>	2.09 mm
Spoed	<b>p</b>	1.12 mm
Lengte	<b>L</b>	7.00 ±0.45 mm
Kop-Ø	<b>D</b>	6.50 <sub>-0.58</sub> mm
Kop hoogte	<b>K</b>	2.100 ±0.125 mm
Flensdikte	<b>S</b>	0.80 mm
Draaduitloop	<b>X</b>	1.50 mm
Radius	<b>R</b>	0.50 mm
Kruis Maat		H1
Indringdiepte	<b>t</b>	1.15 - 1.61 mm
Draad		STS-plus
Gewicht		0.514 kg / 1000 stuk
Douane tarief nummer		73 181 499