

Spec Sheet STP310300050S

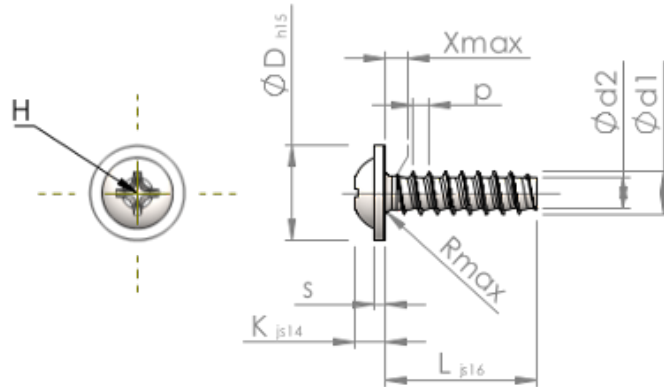

Item Number		STP310300050S
Standard		KN6031
Material		steel, hardened
Surface		zinc-plated 5-7 μ m, baked, blue / transparent passivated
Thread Outside- \varnothing	d1	3.00 $^{+0.10}$ mm
Thread Core- \varnothing	d2	2.09 mm
Thread Pitch	p	1.12 mm
Length	L	5.00 ± 0.38 mm
Head- \varnothing	D	6.50 $_{-0.58}$ mm
Head Height	K	2.100 ± 0.125 mm
Flange Thickness	S	0.80 mm
Thread Run-Out	X	1.50 mm
Radius	R	0.50 mm
Size Cross Recess		H1
Penetration Depth	t	1.15 - 1.61 mm
Thread		STS-plus
Weight		0.446 kg / 1000 pieces
Customs Tariff No		73 181 499