

Technische gegevens
STP310250090E

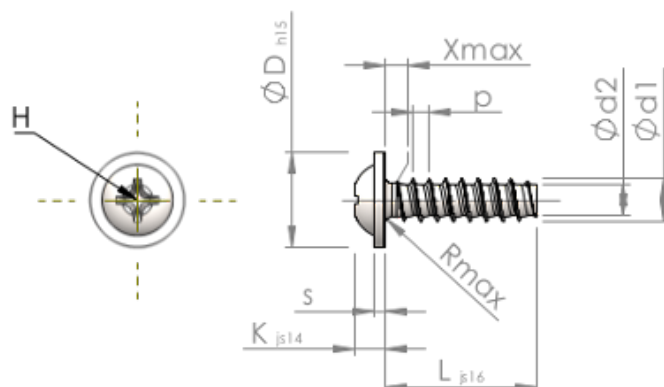

SCREWERK



Produktnummer		STP310250090E
Norm		KN6031
Materiaal		roestvrij staal A2
Oppervlak		blank, geetst en gepassiveerd
Schroefdraad buiten-Ø	d1	2.50 ^{+0.10} mm
Schroefdraad kern-Ø	d2	1.72 mm
Spoed	p	0.95 mm
Lengte	L	9.00 ±0.45 mm
Kop-Ø	D	5.50 _{-0.48} mm
Kop hoogte	K	1.800 ±0.125 mm
Flensdikte	S	0.70 mm
Draaduitloop	X	1.30 mm
Radius	R	0.40 mm
Kruis Maat		H1
Indringdiepte	t	0.82 - 1.28 mm
Draad		STS-plus
Gewicht		0.388 kg / 1000 stuk
Douane tarief nummer		73 181 410