

Spec Sheet STP310250050E

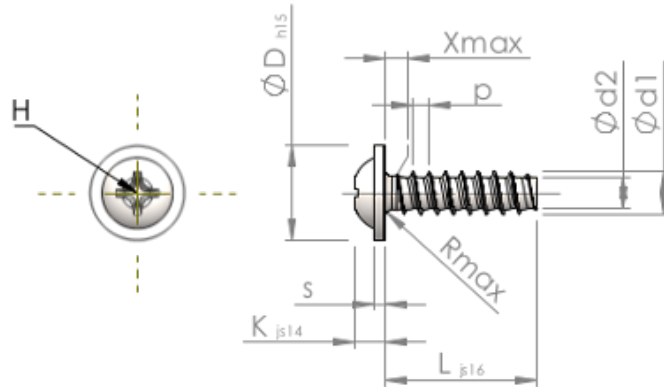

| | | |
|-------------------|-----------|--------------------------------|
| Item Number | | STP310250050E |
| Standard | | KN6031 |
| Material | | stainless-steel A2 |
| Surface | | bright, pickled and passivated |
| Thread Outside-Ø | d1 | 2.50 ^{+0.10} mm |
| Thread Core-Ø | d2 | 1.72 mm |
| Thread Pitch | p | 0.95 mm |
| Length | L | 5.00 ±0.38 mm |
| Head-Ø | D | 5.50 _{-0.48} mm |
| Head Height | K | 1.800 ±0.125 mm |
| Flange Thickness | S | 0.70 mm |
| Thread Run-Out | X | 1.30 mm |
| Radius | R | 0.40 mm |
| Size Cross Recess | | H1 |
| Penetration Depth | t | 0.82 - 1.28 mm |
| Thread | | STS-plus |
| Weight | | 0.292 kg / 1000 pieces |
| Customs Tariff No | | 73 181 410 |