

Spec Sheet STP310220200E

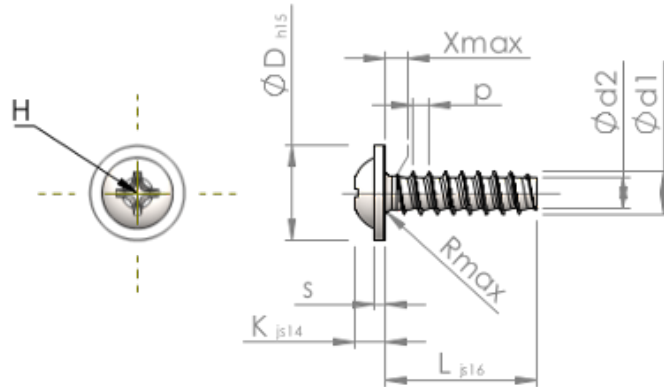

Item Number		STP310220200E
Standard		KN6031
Material		stainless-steel A2
Surface		bright, pickled and passivated
Thread Outside-Ø	<b>d1</b>	2.20 <sup>+0.08</sup> mm
Thread Core-Ø	<b>d2</b>	1.51 mm
Thread Pitch	<b>p</b>	0.85 mm
Length	<b>L</b>	20.00 ±0.65 mm
Head-Ø	<b>D</b>	5.00 <sub>-0.48</sub> mm
Head Height	<b>K</b>	1.600 ±0.125 mm
Flange Thickness	<b>S</b>	0.60 mm
Thread Run-Out	<b>X</b>	1.10 mm
Radius	<b>R</b>	0.35 mm
Size Cross Recess		H1
Penetration Depth	<b>t</b>	0.68 - 1.14 mm
Thread		STS-plus
Weight		0.492 kg / 1000 pieces
Customs Tariff No		73 181 410