

Technische gegevens
STP310220160S

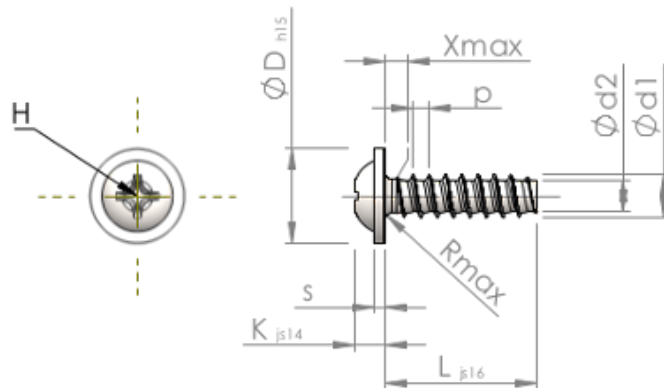

Produktnummer		STP310220160S
Norm		KN6031
Materiaal		veredeld staal
Oppervlak		verzinkt 5-7 µm, getempert, blauw / transparant gepassiveerd
Schroefdraad buiten-Ø	d1	2.20 ^{+0.08} mm
Schroefdraad kern-Ø	d2	1.51 mm
Spoed	p	0.85 mm
Lengte	L	16.00 ±0.55 mm
Kop-Ø	D	5.00 _{-0.48} mm
Kop hoogte	K	1.600 ±0.125 mm
Flensdikte	S	0.60 mm
Draaduitloop	X	1.10 mm
Radius	R	0.35 mm
Kruis Maat		H1
Indringdiepte	t	0.68 - 1.14 mm
Draad		STS-plus
Gewicht		0.418 kg / 1000 stuk
Douane tarief nummer		73 181 499