

Spec Sheet STP310200160S

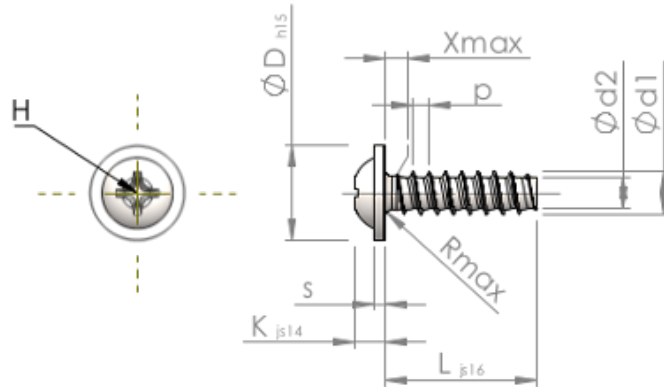

Item Number		STP310200160S
Standard		KN6031
Material		steel, hardened
Surface		zinc-plated 5-7 $\mu$ m, baked, blue / transparent passivated
Thread Outside- $\varnothing$	<b>d1</b>	2.00 $^{+0.08}$ mm
Thread Core- $\varnothing$	<b>d2</b>	1.36 mm
Thread Pitch	<b>p</b>	0.78 mm
Length	<b>L</b>	16.00 $\pm 0.55$ mm
Head- $\varnothing$	<b>D</b>	4.50 $_{-0.48}$ mm
Head Height	<b>K</b>	1.400 $\pm 0.125$ mm
Flange Thickness	<b>S</b>	0.60 mm
Thread Run-Out	<b>X</b>	1.00 mm
Radius	<b>R</b>	0.35 mm
Size Cross Recess		H1
Penetration Depth	<b>t</b>	0.51 - 0.97 mm
Thread		STS-plus
Weight		0.333 kg / 1000 pieces
Customs Tariff No		73 181 499