

**Technische gegevens**  
**STP310200080B**

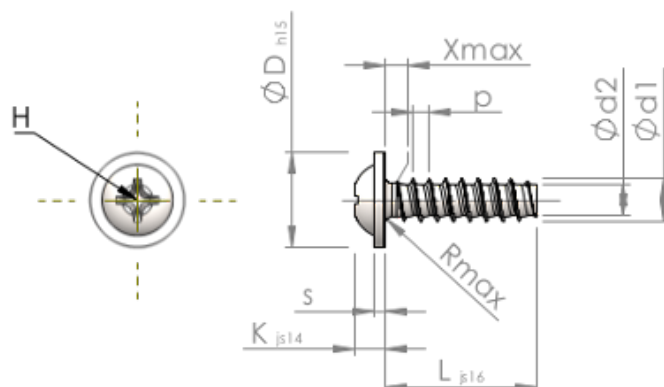

Produktnummer		STP310200080B
Norm		KN6031
Materiaal		veredeld staal
Oppervlak		ZnNi zwart-gepassiveerd, getempert, verzegeld
Schroefdraad buiten-Ø	<b>d1</b>	2.00 <sup>+0.08</sup> mm
Schroefdraad kern-Ø	<b>d2</b>	1.36 mm
Spoed	<b>p</b>	0.78 mm
Lengte	<b>L</b>	8.00 ±0.45 mm
Kop-Ø	<b>D</b>	4.50 <sub>-0.48</sub> mm
Kop hoogte	<b>K</b>	1.400 ±0.125 mm
Flensdikte	<b>S</b>	0.60 mm
Draaduitloop	<b>X</b>	1.00 mm
Radius	<b>R</b>	0.35 mm
Kruis Maat		H1
Indringdiepte	<b>t</b>	0.51 - 0.97 mm
Draad		STS-plus
Gewicht		0.208 kg / 1000 stuk
Douane tarief nummer		73 181 499