

Spec Sheet STP23A0600550E

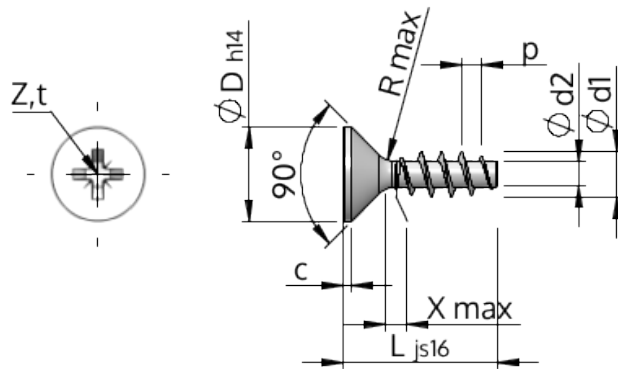

Item Number		STP23A0600550E
Standard		KN1033
Material		stainless-steel A2
Surface		bright, pickled and passivated
Thread Outside-Ø	<b>d1</b>	6.00 <sup>+0.18</sup> mm
Thread Core-Ø	<b>d2</b>	3.19 mm
Thread Pitch	<b>p</b>	2.69 mm
Length	<b>L</b>	55.00 ±0.95 mm
Head-Ø	<b>D</b>	11.30 <sub>-0.43</sub> mm
Cylindrical Head Height	<b>C</b>	0.55 mm
Thread Run-Out	<b>X</b>	3.00 mm
Radius	<b>R</b>	0.60 mm
Size Cross Recess		Z2
Penetration Depth	<b>t</b>	2.60 - 3.06 mm
Thread		STS
Weight		6.748 kg / 1000 pieces
Customs Tariff No		73 181 410