

Spec Sheet STP23A0600220E

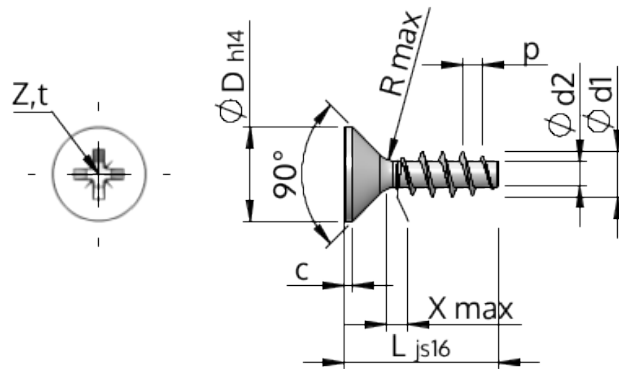

Item Number		STP23A0600220E
Standard		KN1033
Material		stainless-steel A2
Surface		bright, pickled and passivated
Thread Outside-Ø	d1	6.00 ^{+0.18} mm
Thread Core-Ø	d2	3.19 mm
Thread Pitch	p	2.69 mm
Length	L	22.00 ±0.65 mm
Head-Ø	D	11.30 _{-0.43} mm
Cylindrical Head Height	C	0.55 mm
Thread Run-Out	X	3.00 mm
Radius	R	0.60 mm
Size Cross Recess		Z2
Penetration Depth	t	2.60 - 3.06 mm
Thread		STS
Weight		3.379 kg / 1000 pieces
Customs Tariff No		73 181 410