

Technische gegevens
STP23A0600160E

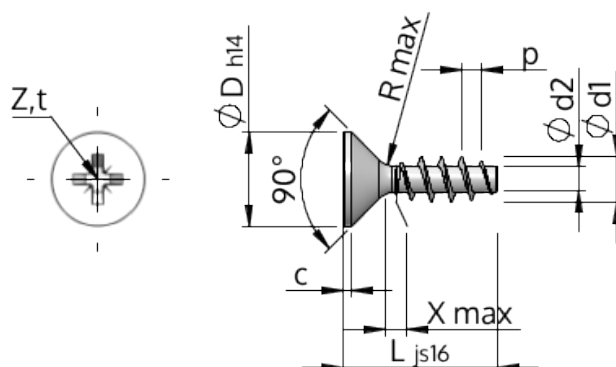

Produktnummer		STP23A0600160E
Norm		KN1033
Materiaal		roestvrij staal A2
Oppervlak		blank, geetst en gepassiveerd
Schroefdraad buiten-Ø	d1	6.00 ^{+0.18} mm
Schroefdraad kern-Ø	d2	3.19 mm
Spoed	p	2.69 mm
Lengte	L	16.00 ±0.55 mm
Kop-Ø	D	11.30 _{-0.43} mm
Cylindrische kophoogte	C	0.55 mm
Draaduitloop	X	3.00 mm
Radius	R	0.60 mm
Kruis Maat		Z2
Indringdiepte	t	2.60 - 3.06 mm
Draad		STS
Gewicht		2.766 kg / 1000 stuk
Douane tarief nummer		73 181 410