

Technische gegevens
STP23A0500160E

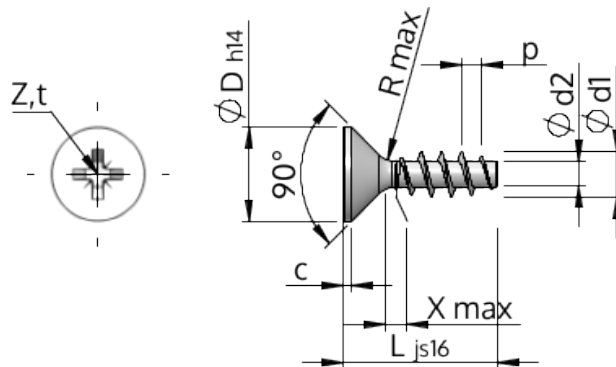

Produktnummer		STP23A0500160E
Norm		KN1033
Materiaal		roestvrij staal A2
Oppervlak		blank, geetst en gepassiveerd
Schroefdraad buiten-Ø	d1	5.00 ^{+0.18} mm
Schroefdraad kern-Ø	d2	2.68 mm
Spoed	p	2.24 mm
Lengte	L	16.00 ±0.55 mm
Kop-Ø	D	9.30 _{-0.36} mm
Cylindrische kophoogte	C	0.50 mm
Draaduitloop	X	2.50 mm
Radius	R	0.45 mm
Kruis Maat		Z2
Indringdiepte	t	2.06 - 2.52 mm
Draad		STS
Gewicht		1.648 kg / 1000 stuk
Douane tarief nummer		73 181 410