

Detalii tehnice STP23A0400450E

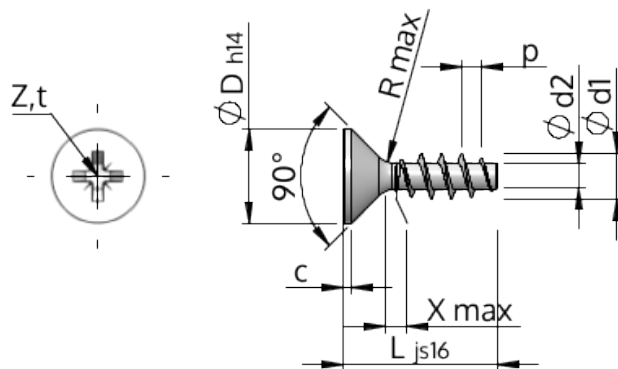

Numărul articolului		STP23A0400450E
Norma		KN1033
Material		oțel inoxidabil A2
Exterior		neacoperit, murat și pasivat
Diametrul exterior al filetului- \varnothing	d1	4.00 ^{+0.18} mm
Diametru șurub	d2	2.17 mm
Pasul filetului	p	1.79 mm
Lungimea	L	45.00 \pm 0.80 mm
Diametrul capului- \varnothing	D	8.40 _{-0.36} mm
Cap cilindric	C	0.45 mm
Tija	X	2.00 mm
Radius	R	0.40 mm
Dimensiune Locaș Cruciform		Z2
Adâncimea de penetrării	t	1.70 - 2.16 mm
Fir		STS
Greutate		2.593 kg / 1000 unități
Tariful vamal nr.		73 181 410