

Spec Sheet STP23A0400200E

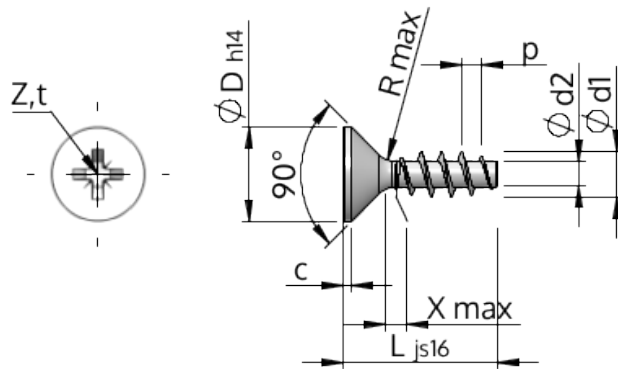

Item Number		STP23A0400200E
Standard		KN1033
Material		stainless-steel A2
Surface		bright, pickled and passivated
Thread Outside-Ø	d1	4.00 ^{+0.18} mm
Thread Core-Ø	d2	2.17 mm
Thread Pitch	p	1.79 mm
Length	L	20.00 ±0.65 mm
Head-Ø	D	8.40 _{-0.36} mm
Cylindrical Head Height	C	0.45 mm
Thread Run-Out	X	2.00 mm
Radius	R	0.40 mm
Size Cross Recess		Z2
Penetration Depth	t	1.70 - 2.16 mm
Thread		STS
Weight		1.386 kg / 1000 pieces
Customs Tariff No		73 181 410