

Spec Sheet STP23A0350250S

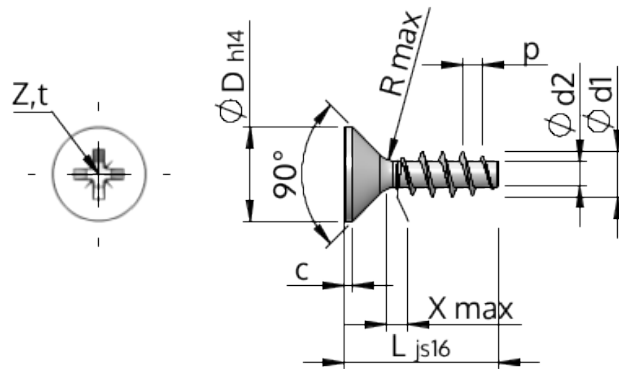

Item Number		STP23A0350250S
Standard		KN1033
Material		steel, hardened
Surface		zinc-plated 5-7 µm, baked, blue / transparent passivated
Thread Outside-Ø	d1	3.50 ^{+0.18} mm
Thread Core-Ø	d2	1.91 mm
Thread Pitch	p	1.57 mm
Length	L	25.00 ±0.65 mm
Head-Ø	D	7.30 _{-0.36} mm
Cylindrical Head Height	C	0.40 mm
Thread Run-Out	X	1.80 mm
Radius	R	0.35 mm
Size Cross Recess		Z2
Penetration Depth	t	1.47 - 1.93 mm
Thread		STS
Weight		1.248 kg / 1000 pieces
Customs Tariff No		73 181 499