

Technische gegevens
STP23A0350180E

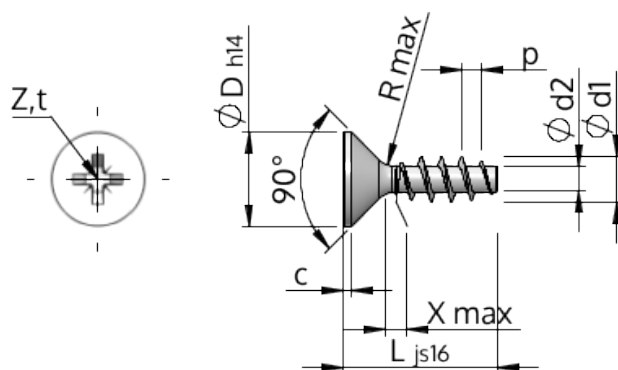

Produktnummer		STP23A0350180E
Norm		KN1033
Materiaal		roestvrij staal A2
Oppervlak		blank, geetst en gepassiveerd
Schroefdraad buiten-Ø	d1	3.50 ^{+0.18} mm
Schroefdraad kern-Ø	d2	1.91 mm
Spoed	p	1.57 mm
Lengte	L	18.00 ±0.55 mm
Kop-Ø	D	7.30 _{-0.36} mm
Cylindrische kophoogte	C	0.40 mm
Draaduitloop	X	1.80 mm
Radius	R	0.35 mm
Kruis Maat		Z2
Indringdiepte	t	1.47 - 1.93 mm
Draad		STS
Gewicht		0.988 kg / 1000 stuk
Douane tarief nummer		73 181 410