

Spec Sheet STP23A0300400E

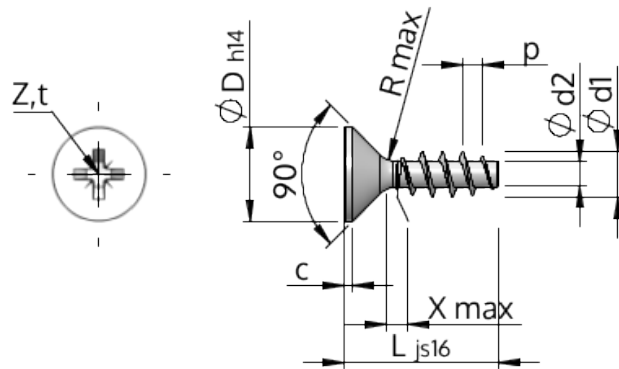

Item Number		STP23A0300400E
Standard		KN1033
Material		stainless-steel A2
Surface		bright, pickled and passivated
Thread Outside-Ø	d1	3.00 ^{+0.14} mm
Thread Core-Ø	d2	1.66 mm
Thread Pitch	p	1.34 mm
Length	L	40.00 ±0.80 mm
Head-Ø	D	5.50 _{-0.30} mm
Cylindrical Head Height	C	0.35 mm
Thread Run-Out	X	1.50 mm
Radius	R	0.35 mm
Size Cross Recess		Z1
Penetration Depth	t	1.20 - 1.45 mm
Thread		STS
Weight		1.252 kg / 1000 pieces
Customs Tariff No		73 181 410