

Technische gegevens
STP23A0300350S

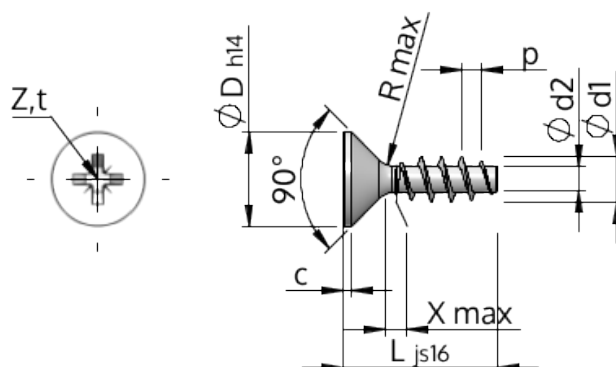

Produktnummer		STP23A0300350S
Norm		KN1033
Materiaal		veredeld staal
Oppervlak		verzinkt 5-7 µm, getempert, blauw / transparant gepassiveerd
Schroefdraad buiten-Ø	d1	3.00 ^{+0.14} mm
Schroefdraad kern-Ø	d2	1.66 mm
Spoed	p	1.34 mm
Lengte	L	35.00 ±0.80 mm
Kop-Ø	D	5.50 _{-0.30} mm
Cylindrische kophoogte	C	0.35 mm
Draaduitloop	X	1.50 mm
Radius	R	0.35 mm
Kruis Maat		Z1
Indringdiepte	t	1.20 - 1.45 mm
Draad		STS
Gewicht		1.108 kg / 1000 stuk
Douane tarief nummer		73 181 499