

Spec Sheet STP23A0250220E

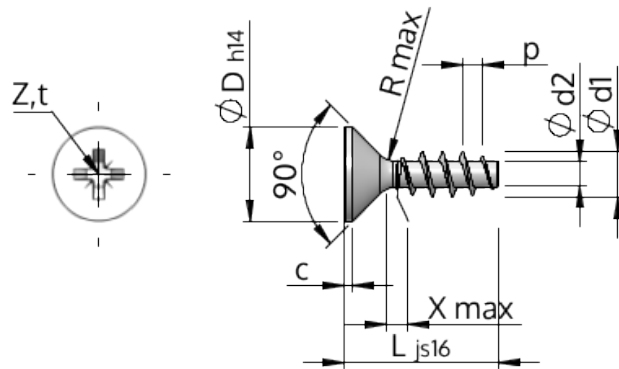

Item Number		STP23A0250220E
Standard		KN1033
Material		stainless-steel A2
Surface		bright, pickled and passivated
Thread Outside-Ø	<b>d1</b>	2.50 <sup>+0.14</sup> mm
Thread Core-Ø	<b>d2</b>	1.40 mm
Thread Pitch	<b>p</b>	1.12 mm
Length	<b>L</b>	22.00 ±0.65 mm
Head-Ø	<b>D</b>	4.70 <sub>-0.30</sub> mm
Cylindrical Head Height	<b>C</b>	0.35 mm
Thread Run-Out	<b>X</b>	1.30 mm
Radius	<b>R</b>	0.30 mm
Size Cross Recess		Z1
Penetration Depth	<b>t</b>	1.09 - 1.34 mm
Thread		STS
Weight		0.508 kg / 1000 pieces
Customs Tariff No		73 181 410