

Spec Sheet STP23A0220160S

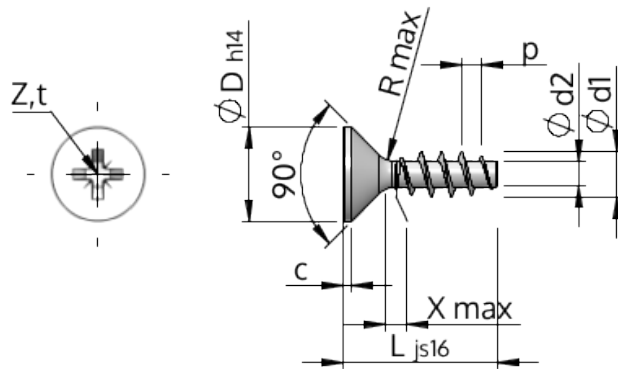

Item Number		STP23A0220160S
Standard		KN1033
Material		steel, hardened
Surface		zinc-plated 5-7 μm , baked, blue / transparent passivated
Thread Outside- \varnothing	d1	2.20 $^{+0.14}$ mm
Thread Core- \varnothing	d2	1.25 mm
Thread Pitch	p	0.98 mm
Length	L	16.00 ± 0.55 mm
Head- \varnothing	D	3.80 $_{-0.30}$ mm
Cylindrical Head Height	C	0.35 mm
Thread Run-Out	X	1.10 mm
Radius	R	0.25 mm
Size Cross Recess		Z1
Penetration Depth	t	0.92 - 1.17 mm
Thread		STS
Weight		0.276 kg / 1000 pieces
Customs Tariff No		73 181 499