

## Detalii tehnice STP23A0200140S

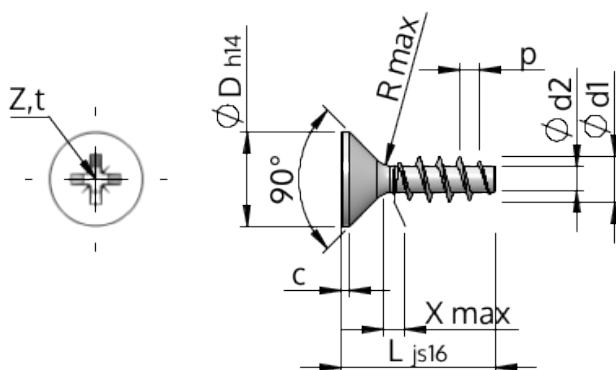

Numărul articolului		STP23A0200140S
Norma		KN1033
Material		oțel, călit
Exterior		zincat 5-7 $\mu$ m, repect, pasivat transparent/albastru
Diametrul exterior al filetului- $\varnothing$	<b>d1</b>	2.00 $^{+0.14}$ mm
Diametru șurub	<b>d2</b>	1.15 mm
Pasul filetului	<b>p</b>	0.89 mm
Lungimea	<b>L</b>	14.00 $\pm 0.55$ mm
Diametrul capului- $\varnothing$	<b>D</b>	3.80 $_{-0.30}$ mm
Cap cilindric	<b>C</b>	0.35 mm
Tija	<b>X</b>	1.00 mm
Radius	<b>R</b>	0.25 mm
Dimensiune Locaș Cruciform		Z1
Adâncimea de penetrării	<b>t</b>	0.92 - 1.17 mm
Fir		STS
Greutate		0.251 kg / 1000 unități
Tariful vamal nr.		73 181 499