

Spec Sheet STP23A0200050S

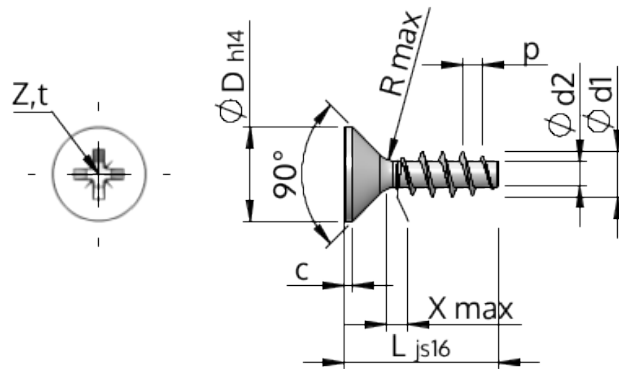

Item Number		STP23A0200050S
Standard		KN1033
Material		steel, hardened
Surface		zinc-plated 5-7 µm, baked, blue / transparent passivated
Thread Outside-Ø	d1	2.00 ^{+0.14} mm
Thread Core-Ø	d2	1.15 mm
Thread Pitch	p	0.89 mm
Length	L	5.00 ±0.38 mm
Head-Ø	D	3.80 _{-0.30} mm
Cylindrical Head Height	C	0.35 mm
Thread Run-Out	X	1.00 mm
Radius	R	0.25 mm
Size Cross Recess		Z1
Penetration Depth	t	0.92 - 1.17 mm
Thread		STS
Weight		0.121 kg / 1000 pieces
Customs Tariff No		73 181 499