

Technische gegevens
STM410800800S

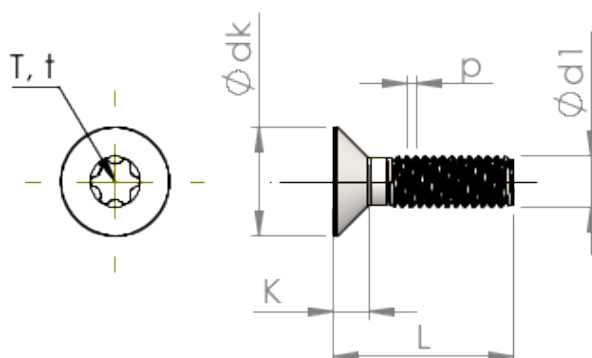

Produktnummer		STM410800800S
Norm		ISO 14581
Materiaal		veredeld staal
Oppervlak		verzinkt 5-7 µm, getempert, blauw / transparant gepassiveerd
Schroefdraad buiten-Ø	d1	8.00 mm
Spoed	p	1.25 mm
Lengte	L	80.00 ±0.95 mm
Kop-Ø	D	15.80 _{-0.43} mm
Cylindrische kophoogte	C	0.95 mm
TX		T45
Indringdiepte	t	2.15 - 2.54 mm
Gewicht		26.143 kg / 1000 stuk
Douane tarief nummer		73 181 595