

Technische gegevens
STM410800700S

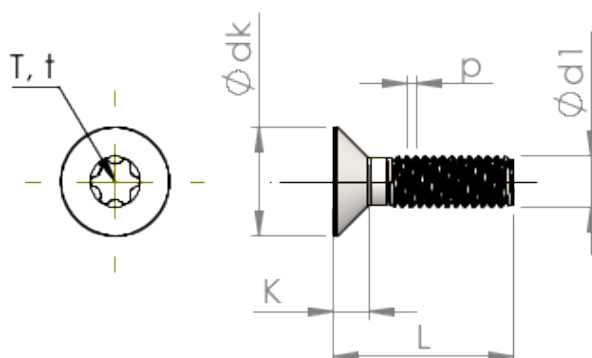

Produktnummer		STM410800700S
Norm		ISO 14581
Materiaal		veredeld staal
Oppervlak		verzinkt 5-7 μm , getempert, blauw / transparant gepassiveerd
Schroefdraad buiten- \emptyset	d1	8.00 mm
Spoed	p	1.25 mm
Lengte	L	70.00 \pm 0.95 mm
Kop- \emptyset	D	15.80 $_{-0.43}$ mm
Cylindrische kophoogte	C	0.95 mm
TX		T45
Indringdiepte	t	2.15 - 2.54 mm
Gewicht		23.093 kg / 1000 stuk
Douane tarief nummer		73 181 595