

Spec Sheet STM410800500B

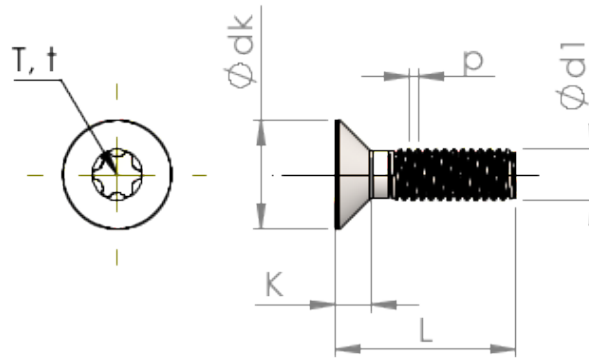

Item Number		STM410800500B
Standard		ISO 14581
Material		steel, hardened
Surface		Zinc-Nickel-plated min. 5µm, passivated black/ Cr-VI-free, baked, sealed
Thread Outside-Ø	<b>d1</b>	8.00 mm
Thread Pitch	<b>p</b>	1.25 mm
Length	<b>L</b>	50.00 ±0.80 mm
Head-Ø	<b>D</b>	15.80 <sub>-0.43</sub> mm
Cylindrical Head Height	<b>C</b>	0.95 mm
Size Six Lobe		T45
Penetration Depth	<b>t</b>	2.15 - 2.54 mm
Weight		16.993 kg / 1000 pieces
Customs Tariff No		73 181 595