

Spec Sheet STM410800350B

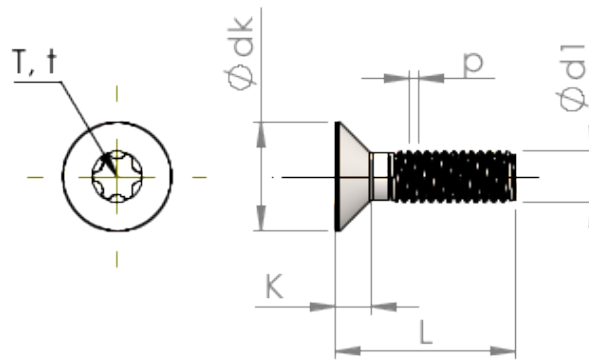

Item Number		STM410800350B
Standard		ISO 14581
Material		steel, hardened
Surface		Zinc-Nickel-plated min. 5µm, passivated black/ Cr-VI-free, baked, sealed
Thread Outside-Ø	d1	8.00 mm
Thread Pitch	p	1.25 mm
Length	L	35.00 ±0.80 mm
Head-Ø	D	15.80 _{-0.43} mm
Cylindrical Head Height	C	0.95 mm
Size Six Lobe		T45
Penetration Depth	t	2.15 - 2.54 mm
Weight		12.418 kg / 1000 pieces
Customs Tariff No		73 181 595