

**Technische gegevens**  
**STM410800300S**

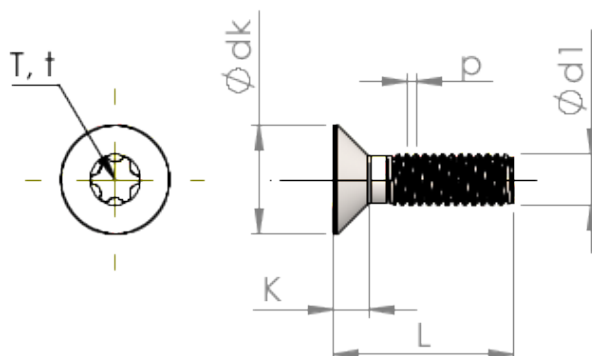

Produktnummer		STM410800300S
Norm		ISO 14581
Materiaal		veredeld staal
Oppervlak		verzinkt 5-7 µm, getempert, blauw / transparant gepassiveerd
Schroefdraad buiten-Ø	<b>d1</b>	8.00 mm
Spoed	<b>p</b>	1.25 mm
Lengte	<b>L</b>	30.00 ±0.65 mm
Kop-Ø	<b>D</b>	15.80 <sub>-0.43</sub> mm
Cylindrische kophoogte	<b>C</b>	0.95 mm
TX		T45
Indringdiepte	<b>t</b>	2.15 - 2.54 mm
Gewicht		10.893 kg / 1000 stuk
Douane tarief nummer		73 181 595