

Technische gegevens
STM410600450E

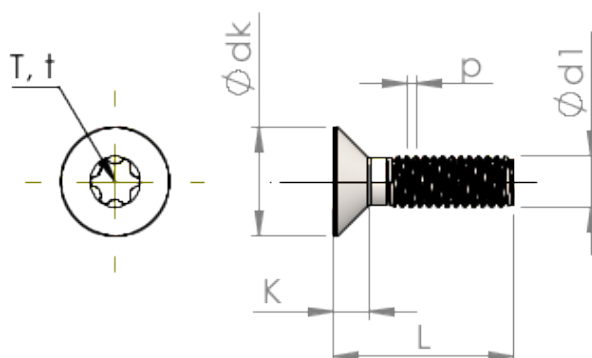

Produktnummer		STM410600450E
Norm		ISO 14581
Materiaal		roestvrij staal A2
Oppervlak		blank, geetst en gepassiveerd
Schroefdraad buiten-Ø	d1	6.00 mm
Spoed	p	1.00 mm
Lengte	L	45.00 ±0.80 mm
Kop-Ø	D	11.30 _{-0.43} mm
Cylindrische kophoogte	C	0.85 mm
TX		T30
Indringdiepte	t	1.39 - 1.78 mm
Gewicht		8.314 kg / 1000 stuk
Douane tarief nummer		73 181 575