

Detalii tehnice STM410600400S

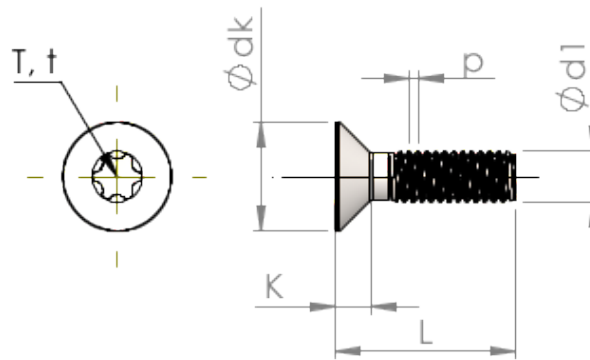

Numărul articolului		STM410600400S
Norma		ISO 14581
Material		oțel, călit
Exterior		zincat 5-7 μm , recopt, pasivat transparent/albastru
Diametrul exterior al filetului- ϕ	d1	6.00 mm
Pasul filetului	p	1.00 mm
Lungimea	L	40.00 \pm 0.80 mm
Diametrul capului- ϕ	D	11.30 $_{-0.43}$ mm
Cap cilindric	C	0.85 mm
hexalobular		T30
Adâncimea de penetrării	t	1.39 - 1.78 mm
Greutate		7.474 kg / 1000 unități
Tarifal vamal nr.		73 181 595