

Spec Sheet STM410600250S

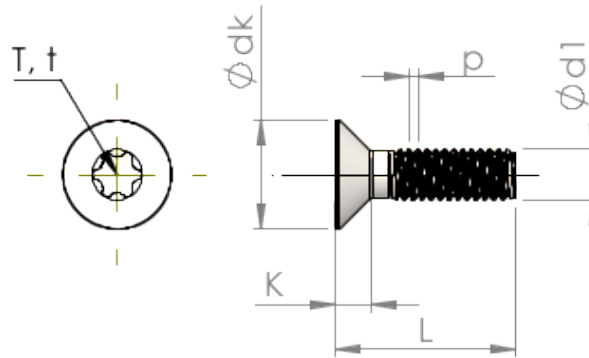

Item Number		STM410600250S
Standard		ISO 14581
Material		steel, hardened
Surface		zinc-plated 5-7 µm, baked, blue / transparent passivated
Thread Outside-Ø	d1	6.00 mm
Thread Pitch	p	1.00 mm
Length	L	25.00 ±0.65 mm
Head-Ø	D	11.30 _{-0.43} mm
Cylindrical Head Height	C	0.85 mm
Size Six Lobe		T30
Penetration Depth	t	1.39 - 1.78 mm
Weight		4.954 kg / 1000 pieces
Customs Tariff No		73 181 595