

Detalii tehnice STM410600250E

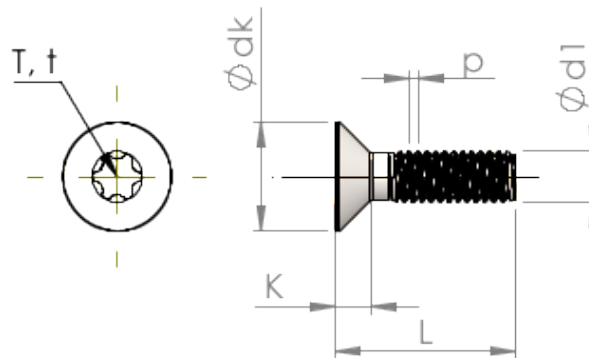

Numărul articolului		STM410600250E
Norma		ISO 14581
Material		oțel inoxidabil A2
Exterior		neacoperit, murat și pasivat
Diametrul exterior al filetului-Ø	d1	6.00 mm
Pasul filetului	p	1.00 mm
Lungimea	L	25.00 ±0.65 mm
Diametrul capului-Ø	D	11.30 _{-0.43} mm
Cap cilindric	C	0.85 mm
hexalobular		T30
Adâncimea de penetrării	t	1.39 - 1.78 mm
Greutate		4.954 kg / 1000 unități
Tarifal vamal nr.		73 181 575