

Spec Sheet STM410600140B

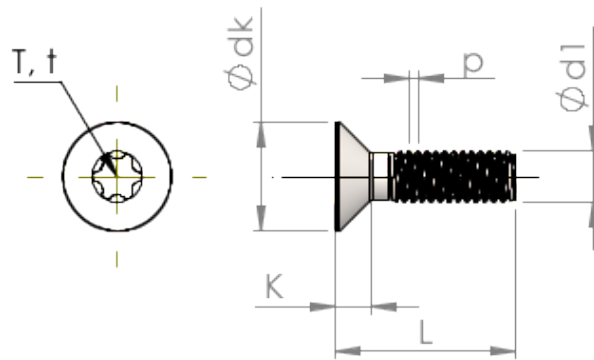

Item Number		STM410600140B
Standard		ISO 14581
Material		steel, hardened
Surface		Zinc-Nickel-plated min. 5µm, passivated black/ Cr-VI-free, baked, sealed
Thread Outside-Ø	d1	6.00 mm
Thread Pitch	p	1.00 mm
Length	L	14.00 ±0.55 mm
Head-Ø	D	11.30 _{-0.43} mm
Cylindrical Head Height	C	0.85 mm
Size Six Lobe		T30
Penetration Depth	t	1.39 - 1.78 mm
Weight		3.107 kg / 1000 pieces
Customs Tariff No		73 181 595