

**Technische gegevens**  
**STM410600080S**

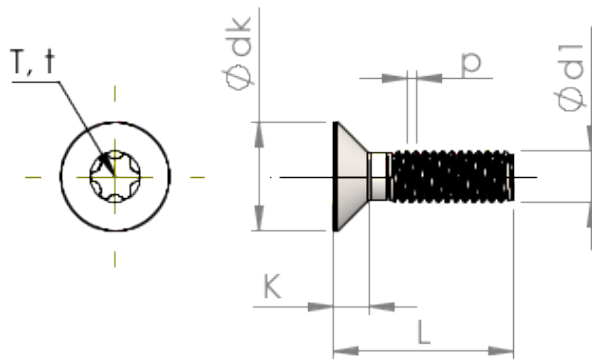

Produktnummer		STM410600080S
Norm		ISO 14581
Materiaal		veredeld staal
Oppervlak		verzinkt 5-7 µm, getempert, blauw / transparant gepassiveerd
Schroefdraad buiten-Ø	<b>d1</b>	6.00 mm
Spoed	<b>p</b>	1.00 mm
Lengte	<b>L</b>	8.00 ±0.45 mm
Kop-Ø	<b>D</b>	11.30 <sub>-0.43</sub> mm
Cylindrische kophoogte	<b>C</b>	0.85 mm
TX		T30
Indringdiepte	<b>t</b>	1.39 - 1.78 mm
Gewicht		2.099 kg / 1000 stuk
Douane tarief nummer		73 181 595