

**Technische gegevens**  
**STM410500850B**

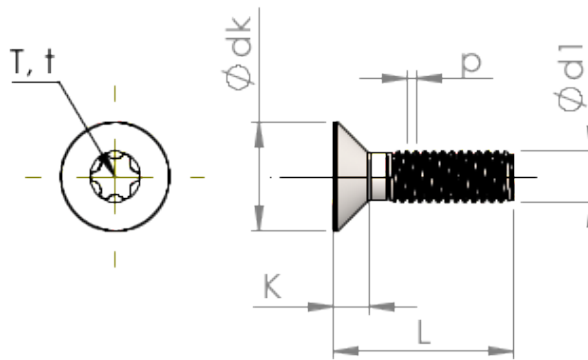

Produktnummer		STM410500850B
Norm		ISO 14581
Materiaal		veredeld staal
Oppervlak		ZnNi zwart-gepassiveerd, getempert, verzegeld
Schroefdraad buiten-Ø	<b>d1</b>	5.00 mm
Spoed	<b>p</b>	0.80 mm
Lengte	<b>L</b>	85.00 ±0.95 mm
Kop-Ø	<b>D</b>	9.30 <sub>-0.36</sub> mm
Cylindrische kophoogte	<b>C</b>	0.75 mm
TX		T25
Indringdiepte	<b>t</b>	1.12 - 1.51 mm
Gewicht		10.615 kg / 1000 stuk
Douane tarief nummer		73 181 595