

Technische gegevens
STM410500650S

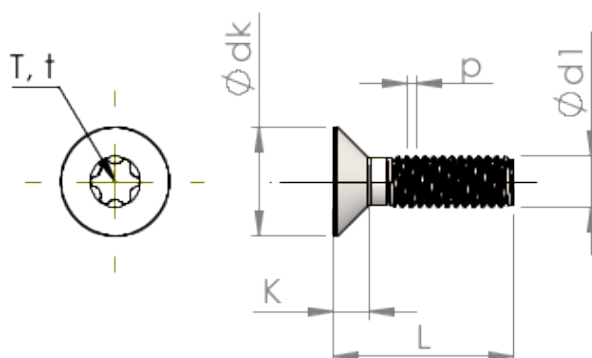

Produktnummer		STM410500650S
Norm		ISO 14581
Materiaal		veredeld staal
Oppervlak		verzinkt 5-7 μm , getempert, blauw / transparant gepassiveerd
Schroefdraad buiten- \emptyset	d1	5.00 mm
Spoed	p	0.80 mm
Lengte	L	65.00 \pm 0.95 mm
Kop- \emptyset	D	9.30 $_{-0.36}$ mm
Cylindrische kophoogte	C	0.75 mm
TX		T25
Indringdiepte	t	1.12 - 1.51 mm
Gewicht		8.220 kg / 1000 stuk
Douane tarief nummer		73 181 595