

Technische gegevens
STM410500600E

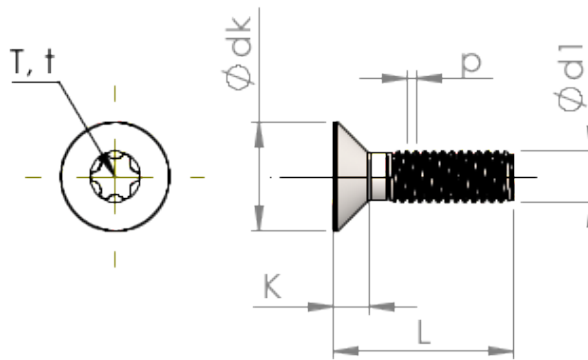

Produktnummer		STM410500600E
Norm		ISO 14581
Materiaal		roestvrij staal A2
Oppervlak		blank, geetst en gepassiveerd
Schroefdraad buiten-Ø	d1	5.00 mm
Spoed	p	0.80 mm
Lengte	L	60.00 ±0.95 mm
Kop-Ø	D	9.30 _{-0.36} mm
Cylindrische kophoogte	C	0.75 mm
TX		T25
Indringdiepte	t	1.12 - 1.51 mm
Gewicht		7.621 kg / 1000 stuk
Douane tarief nummer		73 181 575